

Descoperă mai multe idei creative pe [uhucreativ.ro](http://uhucreativ.ro)!



 PARTICIPĂ

# Creează o MORSĂ



 DECUPEAZĂ **1.**

 LIPEȘTE ÎN  
LUMEA PĂLARĂ **2.**



PARTICIPĂ

# Creează o MORSĂ

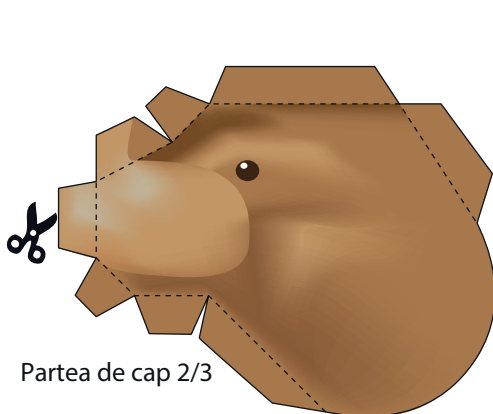

Partea de cap 2/3

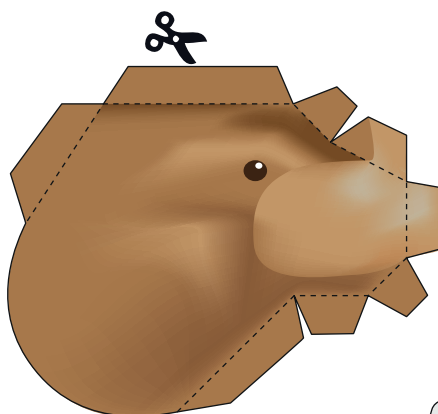

Partea de cap 1/3

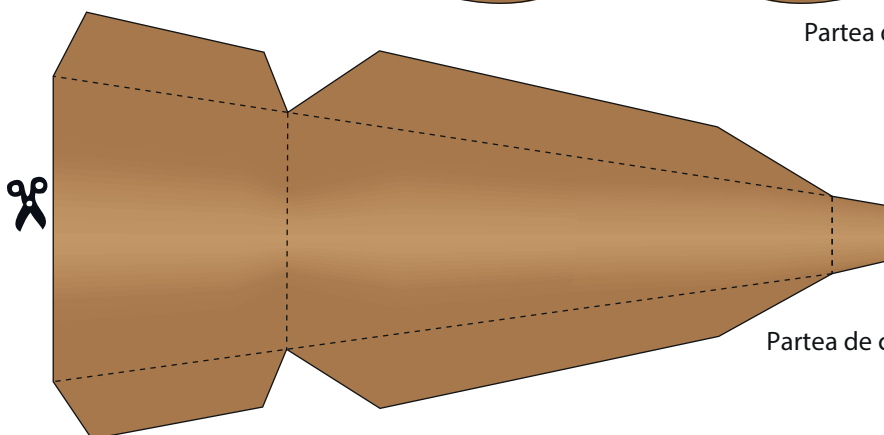

Partea de corp 2/2

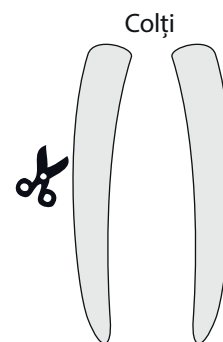

Colți

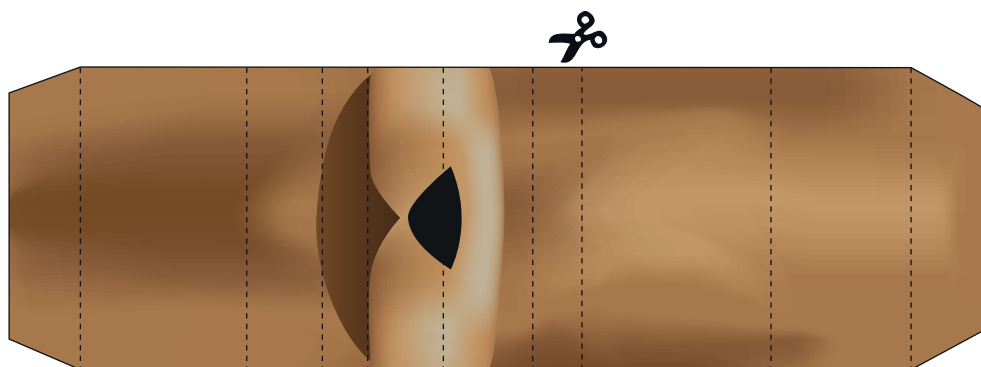

Partea de cap 3/3

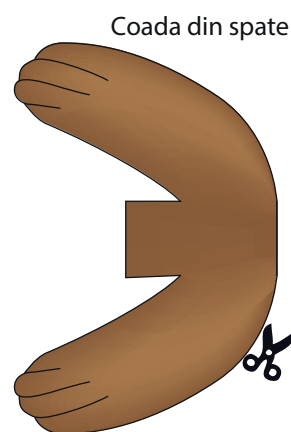

Coadă din spate

**1.** DECUPEAZĂ



 PARTICIPĂ

# Creează o MORSĂ

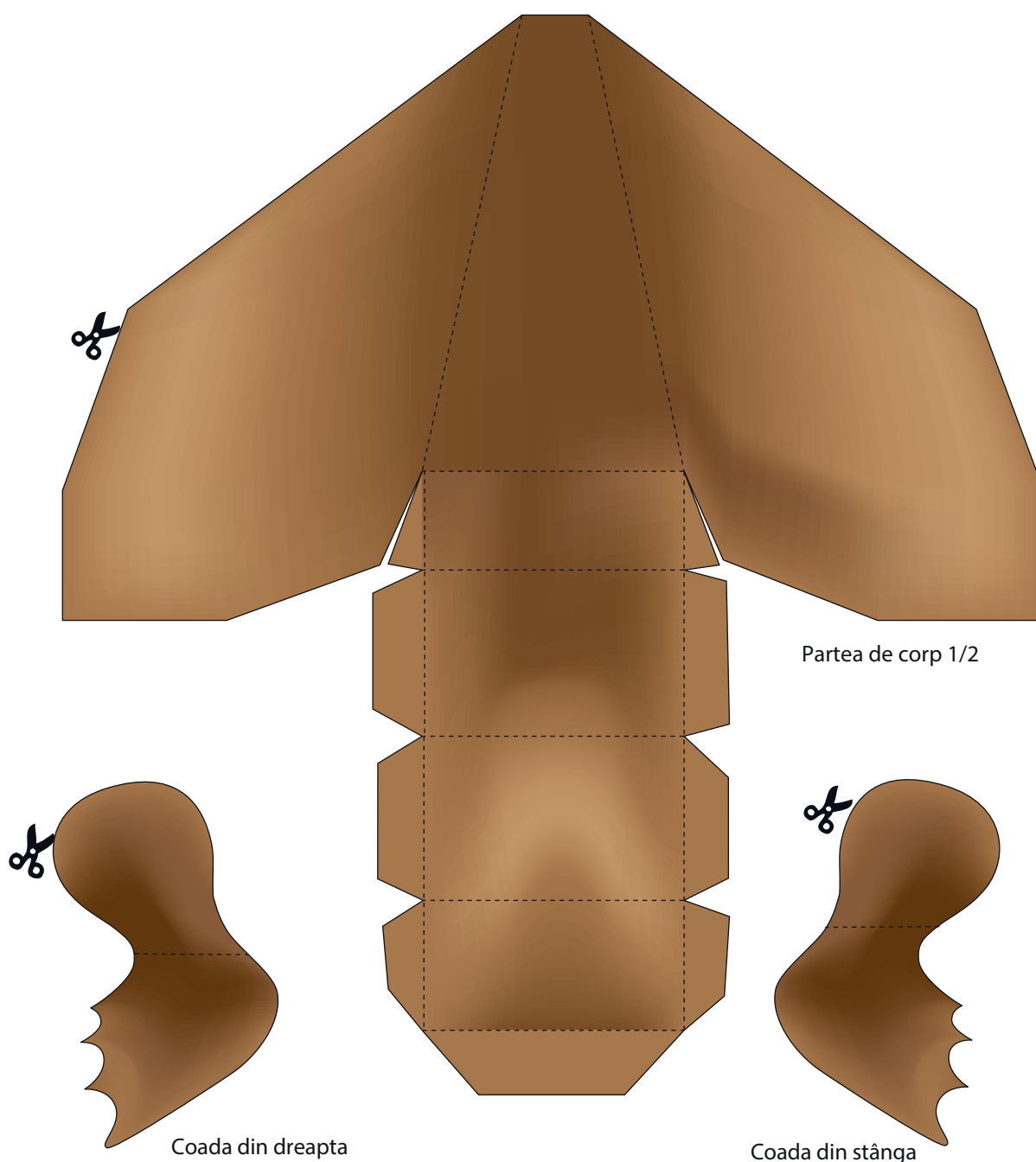

 **1.** DECUPEAZĂ



PARTICIPĂ

# INSTRUCȚIUNI



**Pasul 1:** Decupează toate elementele

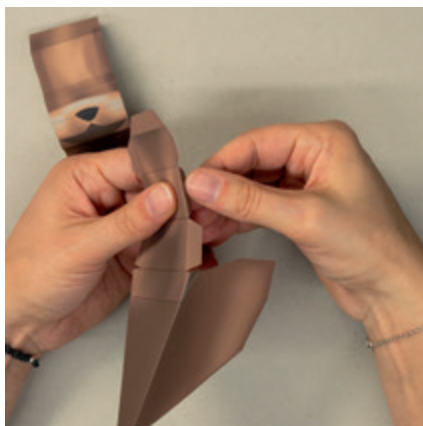

**Pasul 2:** Pliază toate elementele

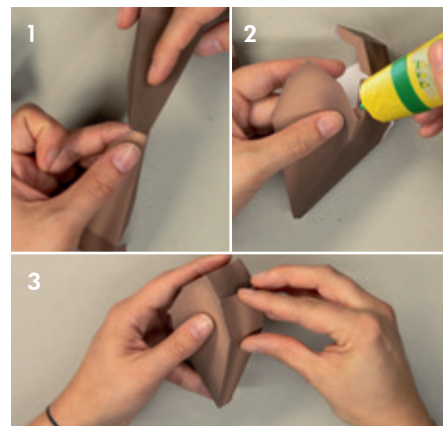

**Pasul 3:** Lipește părțile corpului împreună

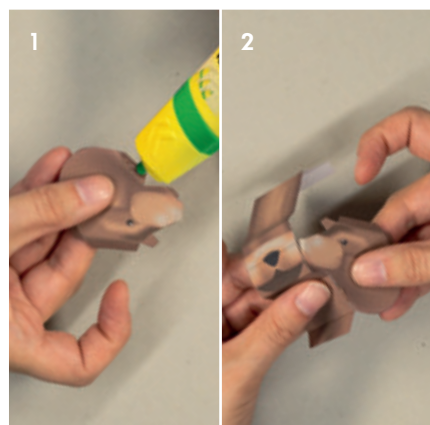

**Pasul 4:** Lipește părțile capului împreună



**Pasul 5:** Lipește capul de corp



**Pasul 6:** Lipește colții de față

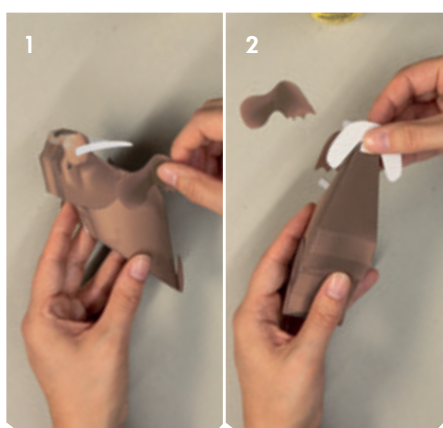

**Pasul 7:** Lipește cozile de corp



Gata!

URMEAZĂ  
INSTRUCȚIUNILE  
**2**

LIPEȘTE ÎN  
LUMEA POLARĂ  
**3**



PARTICIPĂ

Personalizează propria

# MORSĂ

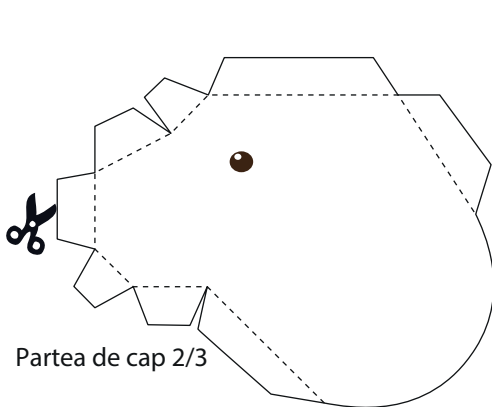

Partea de cap 2/3

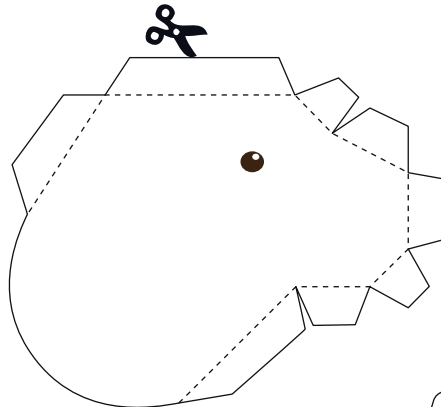

Partea de cap 1/3

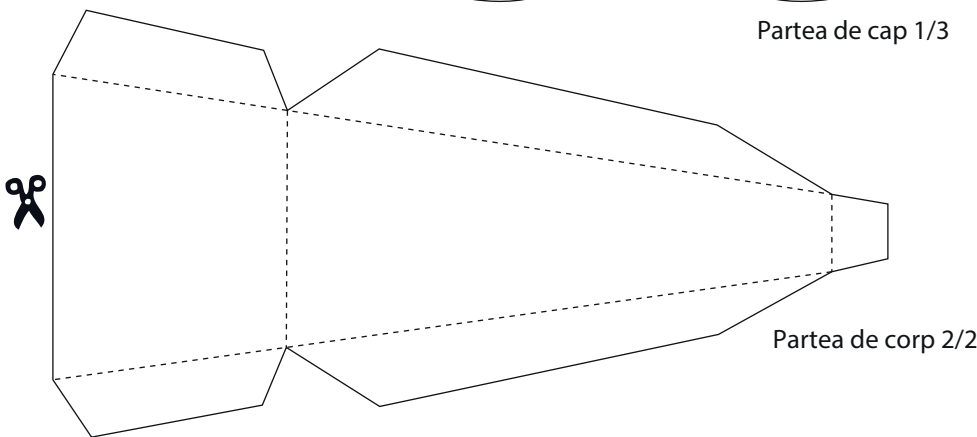

Partea de corp 2/2

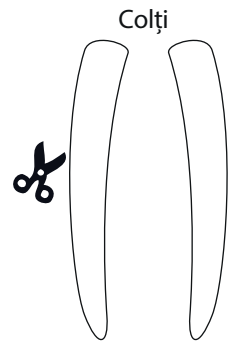

Colți

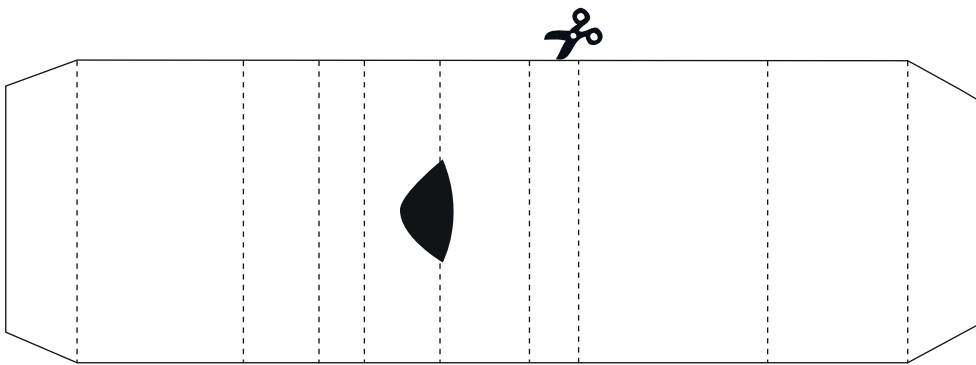

Partea de cap 3/3

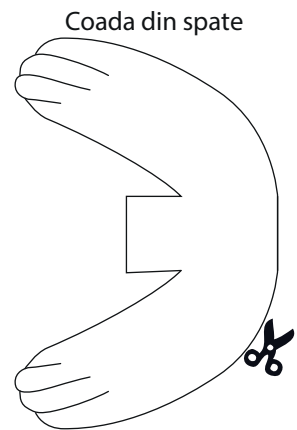

Cooda din spate





PARTICIPĂ

Personalizează propria

# MORSĂ

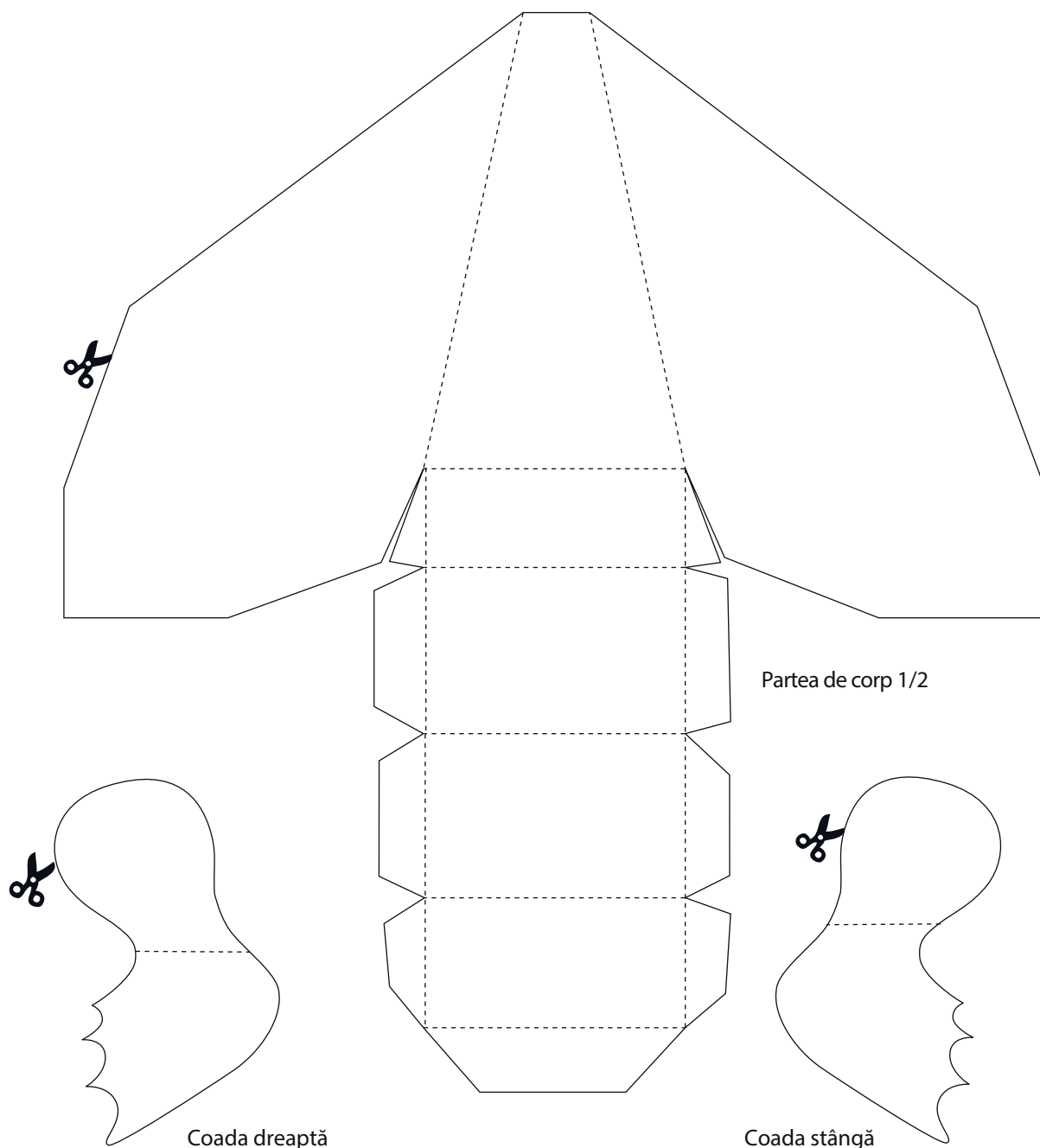

 **1.** DECUPEAZĂ

 **2.** COLOREAZĂ

 **3.** PLIAZĂ ȘI URMEAZĂ INSTRUȚIUNILE

 **4.** LIPEȘTE ÎN LUMEA POLARĂ